

USER GUIDE

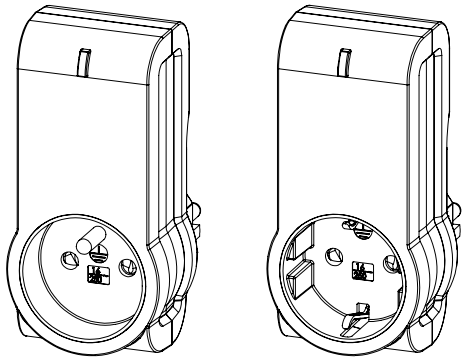

SMART PLUG



Smart Plug Type E
Reference: ASP-2-1-00

Smart Plug Schuko
Reference: ASP-2-1-10

- Power supply: 230V AC +/-10% - 50Hz
- Self-consumption <1W
- Max. power: - 3000W continuous (Resistive load)
- 3500W temporary (Resistive load)
- Radio frequency: 868.3MHz
- Indoor range: 30m
- Operational temperature: -10°C / 50°C
- IP20
- Memory capacity: 24 emitters
- EEP (Profil EnOcean®): D2-01-0A
- Dimensions: L 51mm x l 36mm x h 104mm
- Weight: 137g
- Warranty: 2 years

The NodOn® Smart Plug allows to control (Power ON or Power OFF) an electrical appliance plugged on it: bedside lamp, electrical heater, coffee machine, etc. Once set up (see the set up procedures below), the NodOn® Smart Plug can be controlled by different EnOcean® compliant emitters (wall switch, remote controller, sensor, window handle, card switch, etc.).

Check the compliant emitters list below..

INSTALLATION

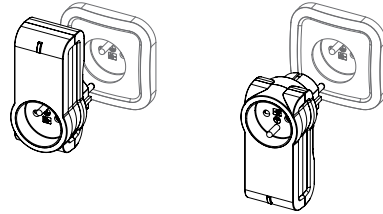

Thanks to an innovative design, the Smart Plug can be mounted on the power outlet in either side, head up or head down.

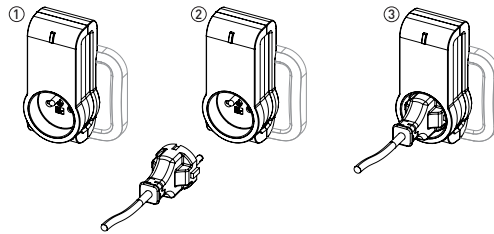

1. Plug the NodOn® Smart Plug on your power outlet.
2. Plug the electrical appliance, you want to control, on the NodOn® Smart Plug.
3. The Smart Plug allows to switch ON (Power ON) or switch OFF (Power OFF) the electrical appliance you want to control.

Switching ON or OFF can be done through the Smart Plug local button, or any kind of emitter paired to the Smart Plug (check the next steps of the user guide).

If the electrical appliance (ex.: bedside lamp) has an ON/OFF button, make sure it's positioned on "ON", in order that the power ON of the appliance by the Smart Plug will switch ON the lamp.

SMART PLUG MODES

"Local Control"

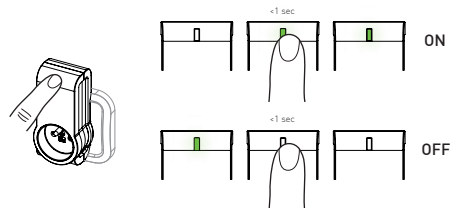

The Smart Plug can be switched ON or OFF locally, through a short press on the local button. By default, the Smart Plug is switched ON when the LED is green, OFF when the LED is OFF.

"Pairing Mode"

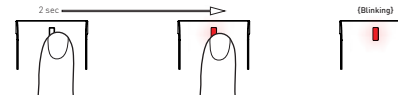

Press on the Smart Plug button during 2 seconds until the LED becomes red. Release the button, the LED will then glow in red. The Smart Plug is in "Pairing mode". To pair an emitter, follow the "Pairing procedures". To confirm that the pairing is OK, the LED will blink in green.

If the LED blinks orange during "Pairing mode", it means that the memory of the Smart Plug is full, or that no emitter has been paired during the process. In case of full memory, please unpair an emitter before being able to pair a new one.

"Factory Reset"

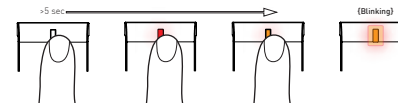

To perform a factory reset, press on the Smart Plug button during 5 seconds until the LED becomes orange. Release the button, the LED will blink red/green. The factory reset will remove all the emitters from the Smart Plug memory, and set all the parameters of the Smart Plug to default value.

PAIRING PROCEDURES

Wall Switch, Remote Controller, etc. EnOcean® Type "Rocker Switch" (EEP: F6-02-01)

To pair this type of emitter to the Smart Plug:

1. Put the Smart Plug in "Pairing mode".
2. Press any button of the emitter. The button pressed during the pairing process is the button which will switch ON the Smart Plug. The opposite button will switch OFF the Smart Plug.

The other buttons of the emitter will not be able to control the Smart Plug.



PAIRING MODE	USAGE	
Button pressed during "Pairing mode"	Button pressed on the emitter	Smart Plug state
○	○	ON
○	⊙	OFF
⊙	○	ON
⊙	⊙	OFF
⊕	⊕	ON
⊕	⊖	OFF
⊖	⊖	ON
⊖	⊕	OFF

- To unpair this emitter:
1. Put the Smart Plug in "Pairing mode".
 2. Press any button of the emitter
- The emitter can't control the Smart Plug anymore.

Key Card Activated Switch

EnOcean® Type "Key Card Activated Switch" (EEP: F6-04-01)

To pair this type of emitter to the Smart Plug:

1. Put the Smart Plug in "Pairing mode".
2. Insert or remove the card from the reader. The movement of the card done during the pairing process is the movement which will switch ON the Smart Plug. The opposite movement will switch OFF the Smart Plug.
3. To initialize the Smart Plug, insert and remove (or remove and insert) the card.



PAIRING MODE	USAGE	
	Card position	Smart Plug state
Movement done during "Pairing mode"	INSERT	ON
	REMOVED	OFF
REMOVE	REMOVED	ON
	INSERTED	OFF

To unpair this emitter:

1. Put the Smart Plug in "Pairing mode".
 2. Insert or remove the card.
- The emitter can't control the Smart Plug anymore.

Window Handle

EnOcean® Type "Window Handle" (EEP: F6-10-00)

To pair this type of emitter to the Smart Plug:

1. Put the Smart Plug in "Pairing mode".
2. Make the relevant movement with the handle according to your need. Check below table.

Note: "Bottom hung" and "Open" position are identically considered

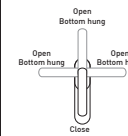

PAIRING MODE	USAGE	
	Handle position	Smart Plug state
Movement done during "pairing mode"	OPENED or BOTTOM HUNG	OFF
	CLOSED	ON
CLOSE	CLOSED	ON
	OPENED or BOTTOM HUNG	OFF

To unpair this emitter

1. Put the Smart Plug in "pairing mode".
 2. Make any kind of movement with the handle.
- The emitter can't control the Smart Plug anymore.

Opening sensor

EnOcean® Type "Magnetic Contact" (EEP: D5-00-01)

To pair this type of emitter to the Smart Plug:

1. Put the Smart Plug in "Pairing mode".
2. Press on the "learning" button of the opening sensor. The position [close or far] of the magnet from the sensor when the "learning" button is pressed is the position which will switch ON the Smart Plug. The opposite position will switch OFF the Smart Plug. Check the table below.

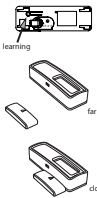

PAIRING MODE	USAGE	
Magnet position when the "Learning" button is pressed	Magnet position	Smart Plug state
	CLOSE	CLOSE ON FAR OFF
FAR	FAR	CLOSE ON CLOSE OFF

To unpair this emitter:

1. Put the Smart Plug in "pairing mode".
2. Press on the "learning" button

The emitter can't control the Smart Plug anymore.

Motion sensor

EnOcean® Type "PIR Sensor" (EEP: A5-07-01 / A5-07-02 / A5-07-03 / A5-08-01 / A5-08-02 / A5-08-03)

To pair this type of emitter to the Smart Plug:

1. The status of the Smart Plug (ON or OFF) chose before put in "pairing mode" will be associate to a presence detection
2. Put the Smart Plug in "pairing mode".
3. Press the "learning" button of the presence sensor.

When a presence is detected, the Smart Plug will be in the state (ON or OFF) defined at step 1.

When no presence is detected, the Smart Plug will be in the opposite state. Check the table below.

PAIRING MODE	USAGE	
Smart Plug state before "pairing mode"	Sensor status	Smart Plug state
	ON	PRESENCE ON NO PRESENCE OFF
OFF	NO PRESENCE	ON PRESENCE OFF

To unpair this emitter:

1. Put the Smart Plug in "pairing mode".
2. Press on the "learning" button

The emitter can't control the Smart Plug anymore

Dry contact sensor

EnOcean® Type "Dry Contact" (EEP: A5-10-0A / A5-10-0B / A5-14-01 / A5-14-02 / A5-14-03 / A5-14-04)

To pair this type of emitter to the Smart Plug:

1. The status of the Smart Plug (ON or OFF) chose before put in "pairing mode" will be associate to a closed circuit.
2. Put the Smart Plug in "pairing mode".
3. Press the "learning" button of the dry contact sensor.

When the contact is closed, the Smart Plug will be in the state (ON or OFF) defined at step 1.

When the contact is open, the Smart Plug will be in the opposite state. Check the table below.

PAIRING MODE	USAGE	
Smart Plug state before "pairing mode"	Contact status	Smart Plug state
	ON	CLOSE ON OPEN OFF
OFF	OPEN	ON CLOSE OFF

To unpair this emitter:

1. Put the Smart Plug in "pairing mode".
 2. Press on the "learning" button
- The emitter can't control the Smart Plug anymore.

HOME AUTOMATION GATEWAY

Pair the Smart Plug with a Home Automation gateway

The NodOn® Smart Plug can be controlled by an EnOcean® compliant Home Automation gateway. For the pairing process of the Smart Plug with the gateway, please refer to the user guide of your Home Automation gateway.

Below, a standard learning process:

1. Put your gateway in learning mode
2. Put the Smart Plug in "Pairing mode".
3. The interface of your gateway will confirm the success of the pairing process.

Nota: To unpair the Smart Plug, the procedure is the same Find the list of the supported Home Automation gateway on www.nodon.fr - "Support" section.

Parameters of the Smart Plug

The NodOn® Smart Plug is bi-directional and follows the D2-01-0A EnOcean® Equipment Profile (EEP).

PARAMETERS	D2-01-0A
No. Of output channels	1
Switching	X
Local control	X
Local control enable/disable	X
Taught-in devices enable/disable	X
User interface day/night mode	X
Default state configurable	X
Power Failure Detection	X
Power Failure Detection enable/disable	X

Default Parameters

PARAMETERS	DEFAULT
Local control enable/disable	Enable
Taught-in devices enable/disable	Enable
User interface day/night mode	Day
Default state configurable	Previous State
Power Failure Detection enable/disable	Disable
Repeater enable/disable	Disable
Repeater level	Off

Parameters presentation

Switching:

This option is to switch ON or OFF the Smart Plug.

If :

- Output value = (0x00) the Smart Plug is switched OFF
- Output value between (0x01) and (0x64), the Smart Plug is switched ON.

The Smart Plug doesn't have any dimming function.

Local control:

This option is to activate or deactivate the local control of the Smart Plug.

In both case, we can always access to the "Pairing mode" and "Factory Reset".

Taught-in devices:

If the parameter is activated, all the emitters paired to the Smart Plug can control it.

If the parameter is deactivated, only the Home Automation gateway can control the Smart Plug.

User interface day/night mode:

If the parameter is set to "Day", the LED will be green when the Smart Plug is ON, and will be OFF when the Smart Plug is OFF.

If the parameter is set to "Night", the LED will be OFF whatever the Smart Plug state is.

Default State:

This parameter allows defining the state of the Smart Plug after a power failure.

Power Failure:

This parameter allows detecting a power failure on the power outlet, in order to notify the Home Automation gateway. No information is transmitted if this option is deactivated.

Power Failure detection needs the recharge of a tiny battery. The detection is available approx. 5min after plugging in the plug.

For more information about each parameter (function, implementation, etc.) and advanced set-up, please refer to the user guide of your Home Automation gateway.

If you are a Home Automation gateway manufacturer, please refer to the latest version of the "EnOcean® Equipment Profiles (EEP)".

SUPPORTED PROFILES (EEP)

F6-02-01	A5-10-19	A5-10-10
F6-04-01	A5-10-18	A5-10-13
F6-10-00	A5-10-1A	A5-10-16
D5-00-01	A5-10-1B	A5-10-17
A5-07-01	A5-10-1C	A5-10-0A
A5-07-02	A5-10-1D	A5-10-0B
A5-07-03	A5-10-01	A5-14-01
A5-08-01	A5-10-05	A5-14-02
A5-08-02	A5-10-08	A5-14-03
A5-08-03	A5-10-0C	A5-14-04

DECLARATION OF CONFORMITY

EN61058 2002+AE2008: 2008
 NF C 61-314 2008+AE2010: 2010 (Type E)
 DIN 0620 -1: 2013 (Schuko)
 DIN 0620 -2-1: 2013 (Schuko)
 EN301489-1 V1.6.1: 2013
 EN301489-2 V1.6.1: 2013
 EN300220-1 V2.4.1: 2012
 EN300220-2 V1.9.2: 2011
 2012/19/EC WEEE Directive

WARNING!

Unplug the product only when it is powered OFF.
 Do not plug the products one behind the other.
 Do not use the product in a humid area.
 The product must be easy to access once plugged.

PICTOGRAM



This product is compliant with all relevant European standards.



When sorting your waste, please observe the disposal regulations in force. Please place your waste in the facilities provided for that purpose and with all due respect for the environment.



This product must be used indoor only.



This product uses a wireless communication protocol.



This product does not contain any battery, and has a low power consumption.



This product must not be in contact with water.



This product must not be exposed to a temperature higher than 50°C.



This product must not be exposed to any kind of fire or heat source.



This product must not be exposed to a temperature lower than -10°C.



This product is compliant with EnOcean® radio protocol.

CONTACT

NodOn® by ID-RF:

ID-RF SAS

121 rue des Hêtres
 45590 St CYR EN VAL (FRANCE)

Notice en français: www.nodon.fr/notices
 User guide in english: www.nodon.fr/notices
 Manual de usuario en español: www.nodon.fr/notices
 Gebruiksaanwijzing in vlaamse: www.nodon.fr/notices
 Bedienungsanleitung in Deutsch: www.nodon.fr/notices

AFTER SALES

www.nodon.fr section "support"
contact@nodon.fr